

LTE-LINK SE

User Manual v1.0

2019.08



Relevant information

CUAV Official Website

The latest product information can be found on the CUAV official website.

CUAV Official Website: <http://www.cuav.net>.

CUAV Document Center: <http://doc.cuav.net>.

Download CUAV Ground Station

Web Address Input: <http://www.cuav.net/client>. Direct selection of the corresponding client for download use.

Download Mission Planner

Web Address Input: <http://ardupilot.org/planner/docs/mission-planner-installation.html>.

Download QGroundControl

Web Address Input:

https://docs.qgroundcontrol.com/en/getting_started/download_and_install.html.

Contents

| | |
|--|----|
| Product Profile | 5 |
| Introduction | 5 |
| Appearance Description | 5 |
| Functional Description | 7 |
| Beginning Use | 7 |
| Device Binding | 9 |
| Use of Ground Station | 11 |
| Introduction | 11 |
| CUAV GS - Android | 11 |
| Feigong Ground Station - Windows | 15 |
| Feigong Transmission - Windows | 19 |
| Use of Third-Party Ground Station | 25 |
| QGroundControl | 25 |
| Mission Planner | 29 |
| Appendix | 35 |
| Specifications | 35 |
| Relevant Issues | 37 |
| Firmware Restore and Update | 39 |

Product Profile

This section introduces LTE-LINK SE and understand the function and usage method.

Product Profile

Introduces

LTE-LINK SE belongs to the UAV communication link product based on **CUAV Cloud Platform**. Based on public 4G network, UAV data and 1080P high-definition video data are transmitted to CUAV Cloud Platform in real time, and the effect of unrestricted distance is realized. Users can bind UAV of LTE-LINK SE through CUAV Account, one account can bind multiple UAV, and control UAV and watch video streams through CUAV client or custom client.

In the follow-up, **CUAV Cloud Platform** continuous improvement. Users can use the abundant functions of team permission allocation, log storage and background management in corresponding ways. Coming soon.

Appearance description

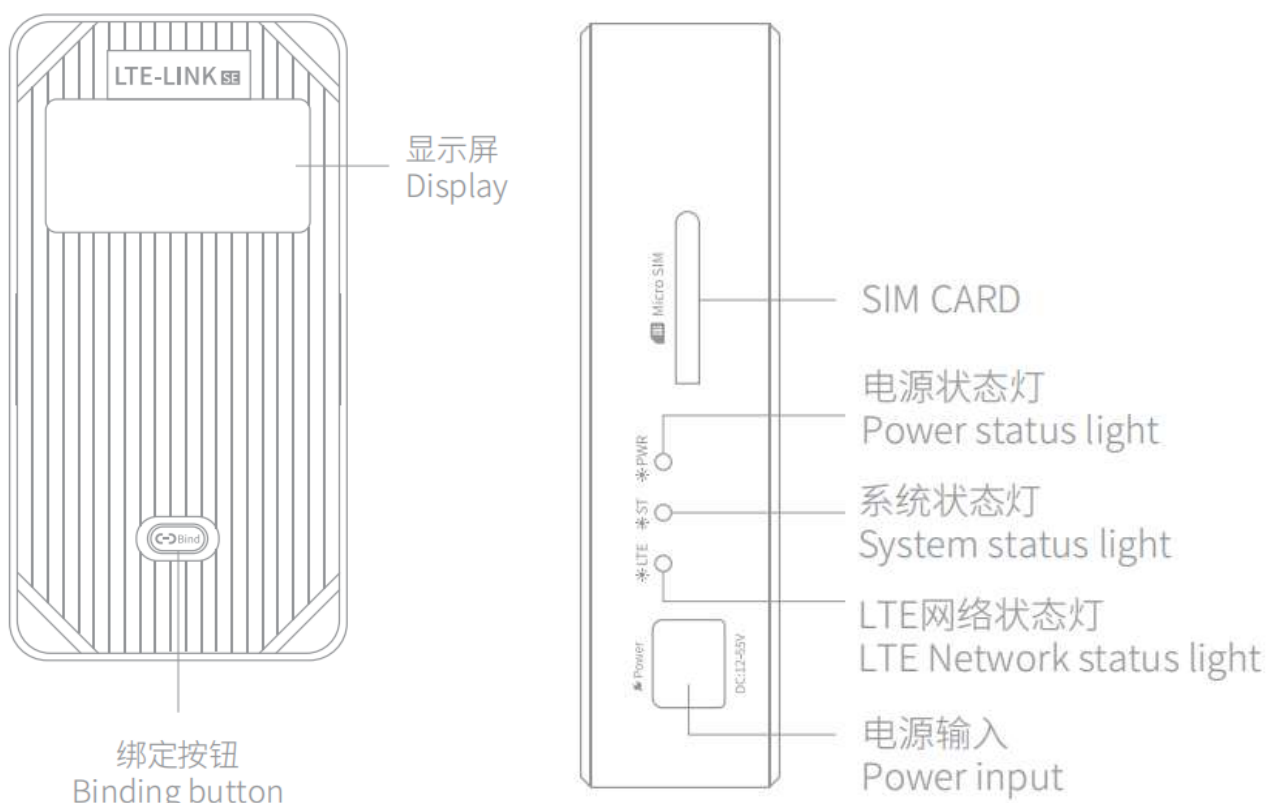

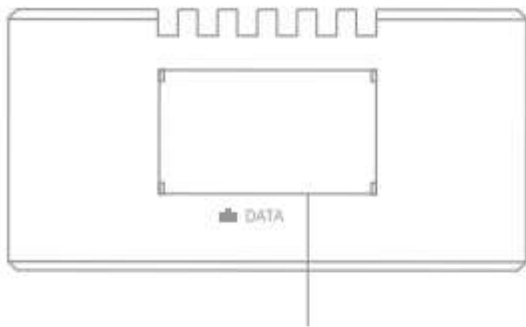

数据线接口
Data interface

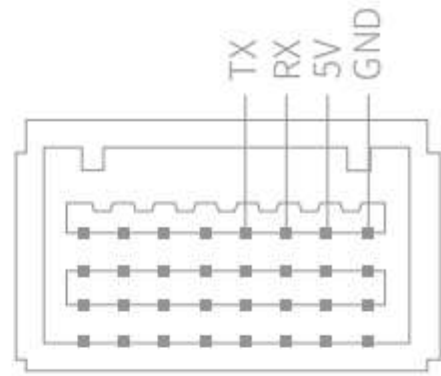

风扇接口
Fan interface

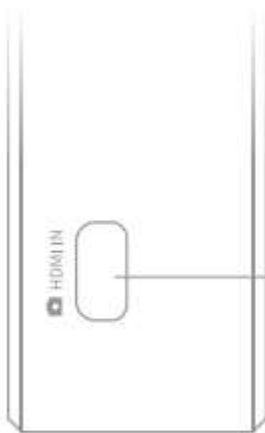

HDMI输入
HDMI Input

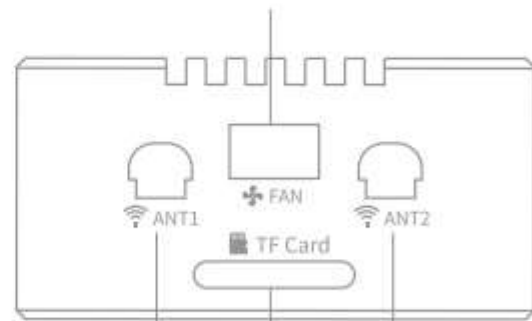

天线1
Antenna 1

天线2
Antenna 2

TF卡
TF Card

Functional Description

LTE-LINK SE supports real-time UAV data, 1080P HD video and auto record flight video.

UAV data - support UAV data of Mavlink, such as CUAV V5+/V5 nano, Pixhack, Pixhawk etc.

Video data - video input is HDMI interface, supporting 1080P and 720P format.

Flight video - The video data is recorded automatically from the unlock of UAV. After the UAV unlocks, the video data is saved. **But unlocking -> unlocking process does not exceed 30S, this video will not be saved.**

Beginning Use

Insert the SIM card of 4G, connect the antenna at both ends, and connect the power line (12 - 55V), so that it can be used on power. Access flight control data of **Data interface** and video data of **HDMI Input**.

Function Menu

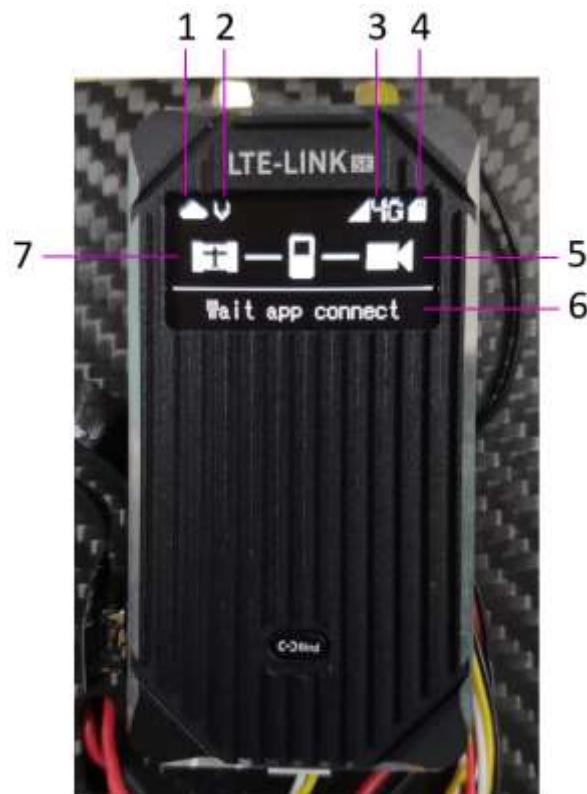

1. Cloud Link

Indicates whether the device is properly connected to the cloud server. To ensure normal data communication, connecting to cloud servers is the prerequisite.

2. Video Transmission

Display/hide indicates that video transmission is currently on/off.

3. Signal State

Network signal strength, network mode.

4. SD Card Status

SD card insertion/pull-out status.

5. Video Input

HDMI Input video stream normal/closed.

6. Information Tips

Information prompt for equipment part.

“Dev init” - Device Initialization.

“sim pppd call” - SIM Card Network Configuration.

“ppp failed” - Network configuration failed, wait for a while. If it continues to fail, you need to check whether the card is in arrears or insufficient traffic.

“Wait time sync” - Wait network time synchronization.

“connecting server” - Connecting cloud server.

“Wait app connect” - The network communication is normal and the client can connect.

“checked update” - Checked system update.

.....

7. Data Input

UART input UAV data is in normal/closed state.

Device Binding

The device needs to be bound one-to-one with the user's account before it can be used properly. Otherwise, the client cannot find the device.

The binding process:

Press the "Bind" button of the device for a long time, usually **more than 3S**, until the QR code appears, it can be released.

CUAV GS mobile phone client can scan the QR code directly to send the binding request (also can use browser scanning, get a series of numbers, in other client's device management input number to send the binding request), the device receives the binding request, and will be prompted to press the "Bind" button again to confirm. If the binding is successful, the device list under the account will appear. **Note: Devices are not allowed to be bound by multiple bindings.** In addition, the equipment runs for a long time, sometimes the temperature is a little high, pay attention to the touch situation.

QR Code



Use of Ground Station

This section introduces Feigong Ground Station, Feigong Transmission and CUAV GS Basic use of LTE-LINK SE.

Use of Ground Station

Introduction

Ground station software mainly helps users acquire UAV data and view video streams in real time. The ground station draws and maintains the route, so that the UAV can achieve the effect of automatic flight. CUAV Ground Station can help users operate better with LTE equipment.

CUAV GS - Android

CUAV GS - Android platform client. Ground stations for Android phones. **Note:** Currently, the V 1.0.0 series only supports data communication of Mavlink 1, and the flight control firmware is Ardupilot.

The user registers and logs in, enters the main menu, chooses the device bound under the account number, clicks on the connection, and enters the device.

Flight Menu



1. Main Menu

Touch this button and return to the main menu.

2. Information Tips

Display flight status and application information.

3. GPS Status

Display the accuracy of the current GPS, Click to see the status of the GPS in detail, the number of satellites searched, specific longitude and latitude values.

4. Data Transmission Status

Display the signal quality of current data transmission.

5. Video Transmission Status

Display the signal quality of the current video transmission. Click to enter the image transfer settings and switch the video quality.

6. Voltage Information

Display the voltage information of the UAV.

7. Current Information

Display current information of the UAV.

8. General Settings

Click on the button to open the general settings menu, which can set the relevant parameters of the UAV, the quality of video transmission, general information etc.

9. SD Card Capacity

Displays the capacity of the SD card connected device.

10. Photo/Video Switch Key

Click on this button to change the mode of photography or video recording. **Note** that the Photo/Video mode only supports LTE-LINK, not SE.

11. Photo/Video Key

Click on the button option to take photos, start video recording, stop video recording.

12. Photo/Video Parameter Keyboard

Select the options to set the photo/video parameters.

13. Flight Status

D: The distance between the UAV and the return point.

H: The vertical distance between the UAV and the return point.

VS: The flight speed of the UAV in the horizontal direction.

HS: The flight speed of the UAV in the vertical direction.

14. Switching Maps

Click on the icon to quickly switch to the map menu.

15. Flight Attitude Display

Click on this icon to open/close the display of UAV attitude.

16. Flight Mode

Display the current flight mode. Click on this option to switch flight mode.

17. Auto Take-off/RTL

Click this button, the UAV will take off or RTL automatically.

18. Arm/Disarm

Click this button to Arm/Disarm the UAV.

CUAV GS - Basic Use

1. Select the connection equipment and enter the flight menu:



2. Basic route drawing menu. Option 1 indicates the opening/closing of route drawing. Option 2 represents the route operation. Clicking on the route can carry out full screen operation, point drawing, route drawing, point selection, deletion and cancellation. Option 3 represents the location point, orientation and map mode.



Feigong Ground Station - Windows

Feigong Ground Station - Windows Platform Client. A ground station for Windows computers.

Note: The current V 2 series is based on QGroundControl Ground Station, and the operation style is as consistent as possible.

Users register and login in the **Application Settings**. In the **Flight Menu**, the device bound under the account is selected for data acquisition.

Flight Menu



1. Application Settings

The application settings include all the settings inside the client, including the registration, login, equipment management and other operations of CUAV Cloud Platform.

2. Autopilot Settings

All parameters and states related to autopilot, including sensor calibration, remote control settings, security settings, view all parameters and other operations.

3. Route Editor

Route-related operations, including point editing, mapping editing, route file preservation and other operations.

4. Flight Menu

View flight status data, switch flight actions, view videos.

5. Logs Operations

Log download, Mavlink console.

6. Device Select

Select the LTE device connected.

7. Video Quality Switch

Click this option to switch the current video quality.

8. Video Settings

View video transmission status, video decoding selection, video caching mode selection.

9. Information Tips

Application information prompt.

10. GPS Status

Display the accuracy and quantity of the current GPS, Click to see the status of GPS in detail.

11. Radio Signal Intensity

Display the signal quality of current data transmission, RSSI parameters of Mavlink.

12. Battery Status

Display the battery information of the UAV, including voltage information and current information.

13. Flight Mode

Display the current flight mode. Click this option to switch flight mode.

14. Disarm/Arm

Clicking on this button will Disarm/Arm the UAV, which requires a sliding prompt box to confirm the operation.

15. Flight Attitude

The display of UAV attitude includes compass, course and other information.

16. Flight Data

Rich flight data, Click the settings button for more parameter.

17. Video Window

The window of real-time video, the icon in the upper right corner of the window pulls the size of the zoom window, the icon in the upper left corner of the window is independent, and the icon in the lower left corner hides the window.

18. Flight Operations

Actions that can be operated directly.

Feigong Ground Station - Basic Use

1. The basic operations of CUAV Cloud Platform: user registration and login, device binding and unbinding, software updating and other operations.

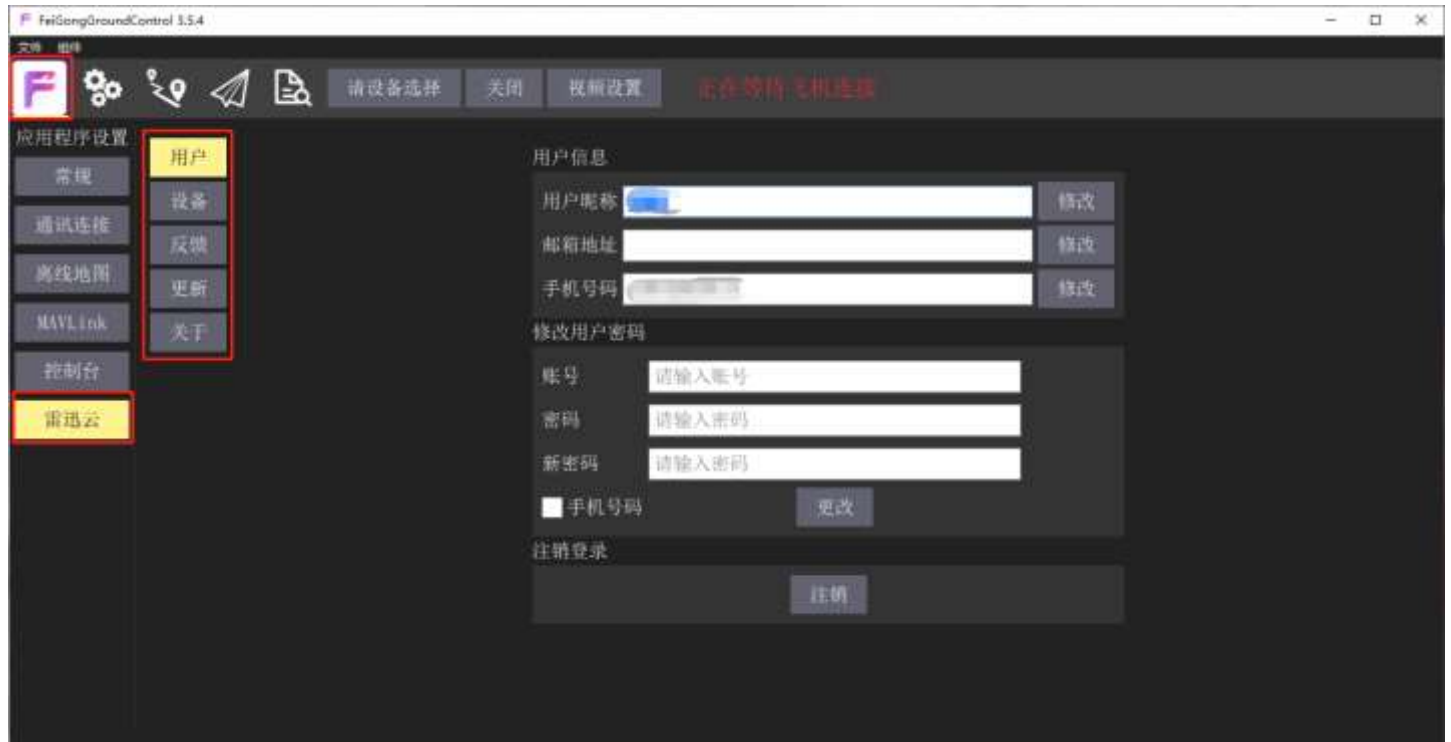

Feigong Transmission - Windows

Feigong Transmission - Windows Platform Client. Help users acquire flight control data and video data in real time **using third-party ground stations**. Moreover, the application itself supports independent video display windows, and supports up to eight video windows. More intuitive monitoring of multiple UAV real-time video pictures.

The user registers and logs in and enters the main menu.

Main Menu

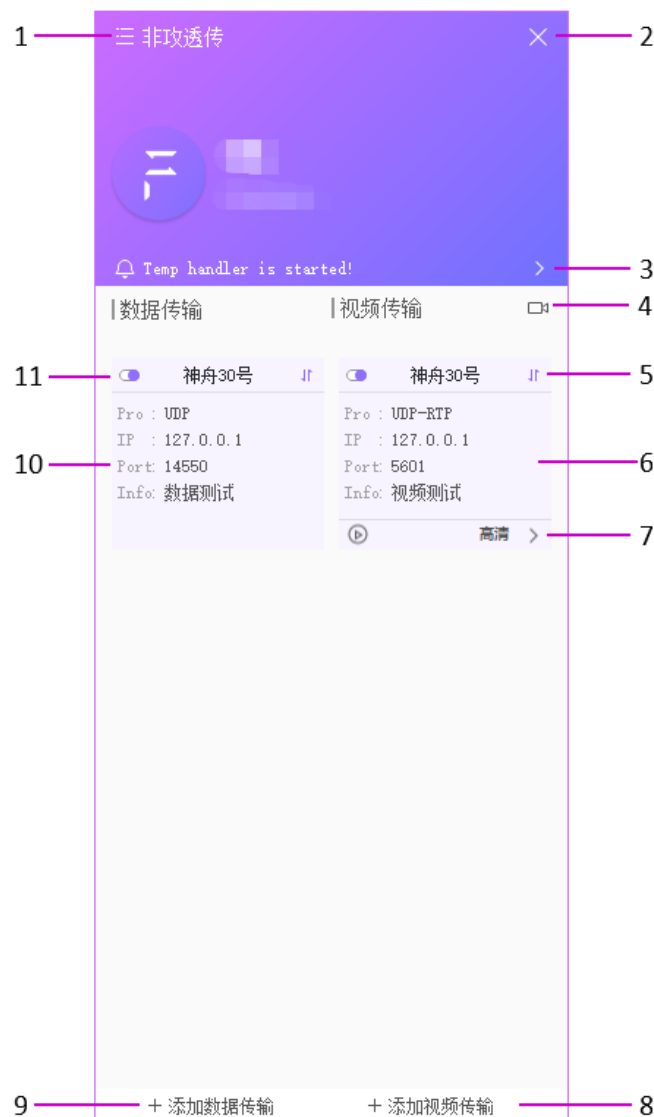

1. Setting Options

Includes equipment management, personal centers, and applications. Equipment management, equipment binding, unbinding, rename and other operations. Personal centers modify the basic information of individuals. For applications, view version information of applications and detect updates.

2. Backstage

After clicking on the button, the application automatically falls back to the background. You can re-click the display application in the background or right-click the background icon to choose to exit.

3. Information Tips

Display all prompts for application.

4. Video Window

Click on the display video window, you can choose the device for real-time video display, maximum support for 8 channels of video window.

5. Data Status

The data identification status indicates the presence of the forwarded device data. If the icon is disconnected, it indicates that the real-time data is not currently available. It is necessary to check whether the data input of the device is normal or whether the network communication is normal.

6. Video Information Bar

Video transmission created will be displayed in the form of information boxes, which show current forwarded IP, ports, associated devices, notes and other information.

7. Video Quality Switch

Click this option to switch the video quality of the device associated.

8. Add Video Transmission

Click Add Video Transfer, select the corresponding communication protocol, input the IP and port of the client, select the device, and confirm the creation of a forwarding message.

9. Add Data Transmission

Click Add Data Transfer, select the corresponding communication protocol, input the IP and port of the client, select the device, and confirm the creation of a forwarding message.

10. Data Information Box

The created data transfers are displayed as information boxes. The information box shows the current forwarded IP, port, associated devices, notes and other information.

11. Open/Close Button

The data transmission and video transmission created can be Open/Close by this button.

Feigong Transmission - Base Use

1. The creation of information boxes is the same as the creation of data or video transmission. Choose the corresponding communication protocol, input the other communication IP and port, select the device, whether need to note information.



2. The use of video window. The display window allows switching the display mode of 1, 2, 4 and 8. Each window can select devices for real-time video display. Note: If the device is not online, there will be no choice. Video supports switching full HD, HD, SD and smooth modes.

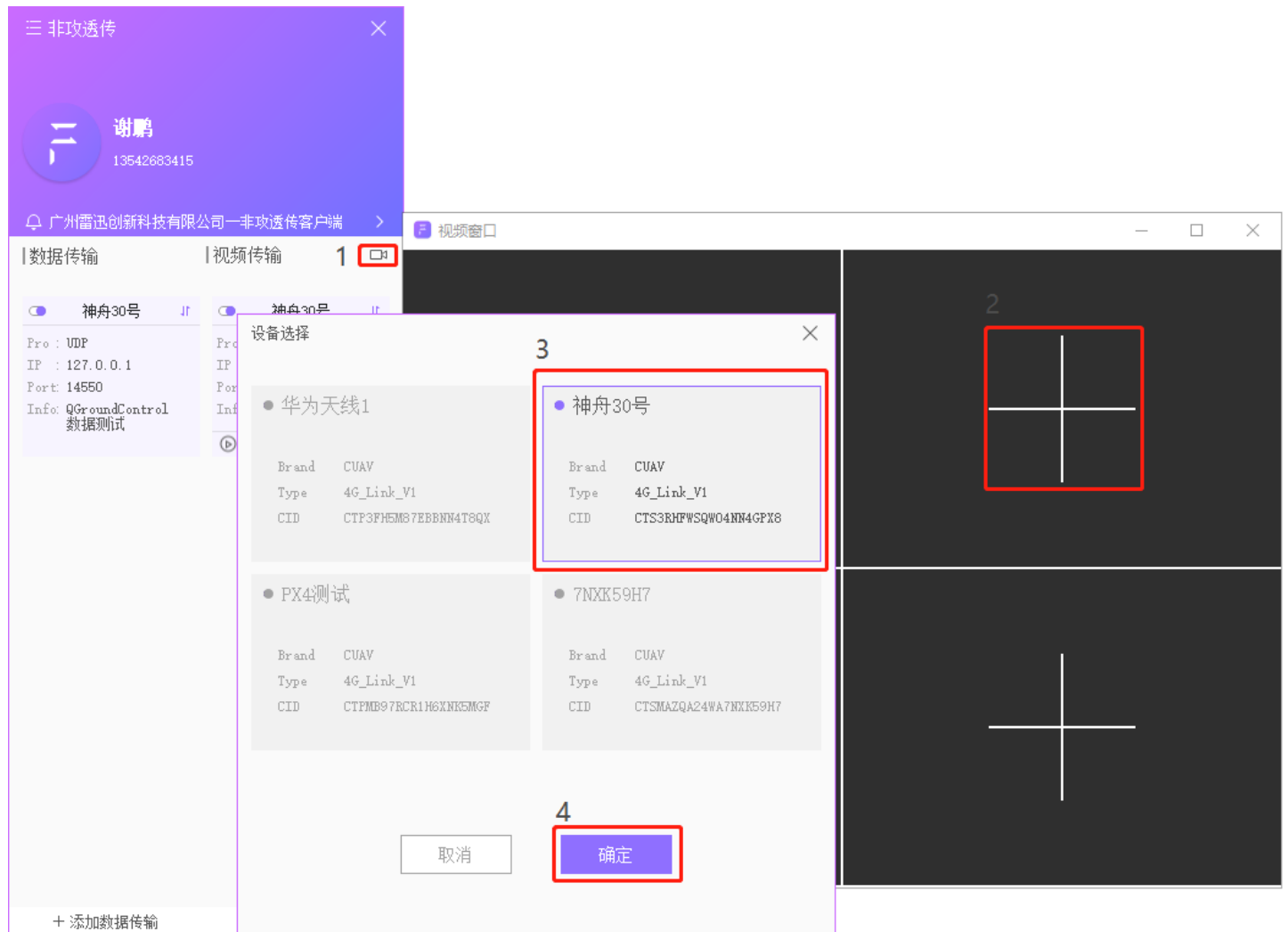

Use of Third-Party Ground Station

This section introduces that use the third-party ground station to control the basic use of LTE-LINK SE. Take Mission Planner and QGroundControl as examples.

Use of Third-Party Ground Station

Expect to use a third-party ground station to control the use of LTE-LINK SE, by reading the following steps, it is very convenient to use. As long as the ground station supports the communication protocol Mavlink 1/2 of open source flight control, the flight control of LTE-LINK SE products can be controlled by a custom ground station. For example, QGround Control, Mission Planner and other ground stations. For users who want to realize UAV cluster planning and monitoring, they can develop their functions in custom ground stations, or find ready ground stations for their own use.

QGroundControl

1. The use of third-party ground stations needs to cooperate with **Feigong Transmission**. The use of Feigong Transmission is introduced in the above chapters. The forwarding communication can be completed by adding "information box".
2. First of all, it is necessary to confirm that the ground station receiving data and the network connection of Feigong Transmission are in the LAN. Then confirm the computer IP and data port of the ground station. If the ground station and Feigong Transmission are on the same computer, the IP address can be directly entered into "127.0.0.1". [The Windows computer obtains the IP method](#). The port can be in the range of 1 - 65535. It is recommended to start from 14550. Note: If port occupancy is unavailable, please replace the port.

3. Now the local communication connection as an example. Adding data transmission for Feigong Transmission, protocol of UDP, IP of “127.0.0.1”, 14550 port and device.



4. Operation of QGroundControl Ground Station. By default, the ground station has opened UDP-14550 communication connection. When you enter the QGroundControl flight menu, you can see that the data is loading and the data is connected to the normal communication.



5. QGroundControl Ground Station can create customized connections, such as creating a UDP-14551 communication without using the default port 14550. The steps are as follows:

(1) Operating on the corresponding options:

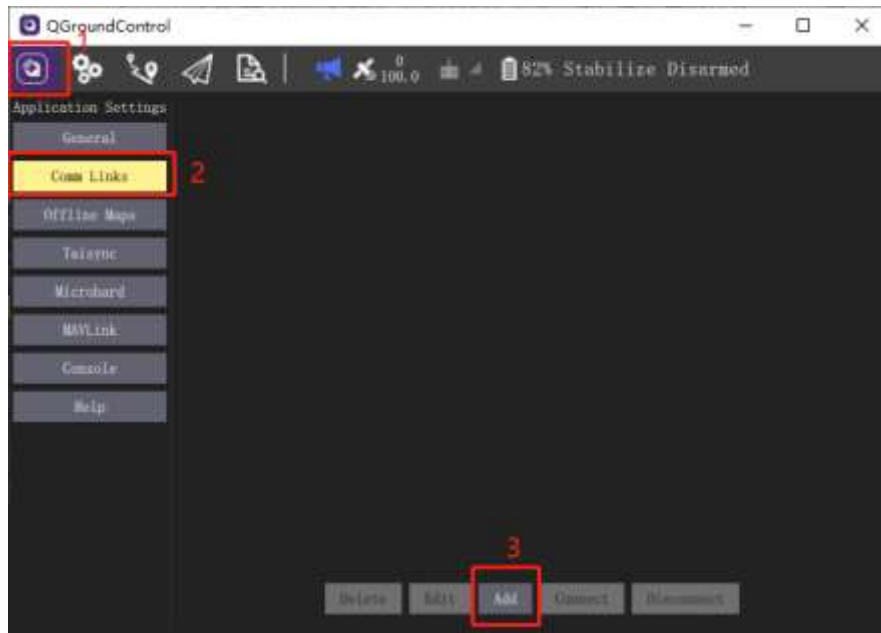

(2) Input the corresponding information option:

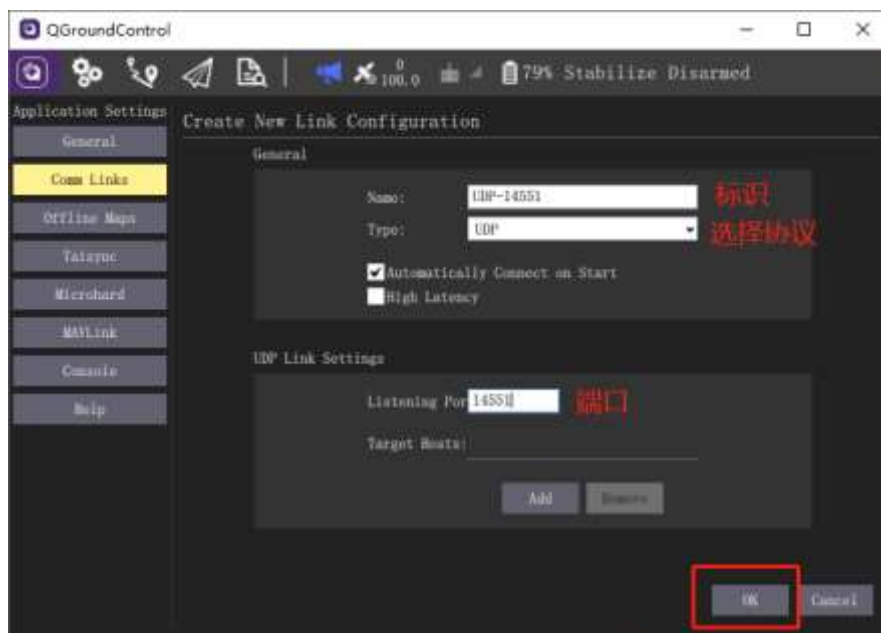

(3) After successful creation, the corresponding connection information will be generated. You can click on the corresponding operation and click on "Connect" to obtain communication data:

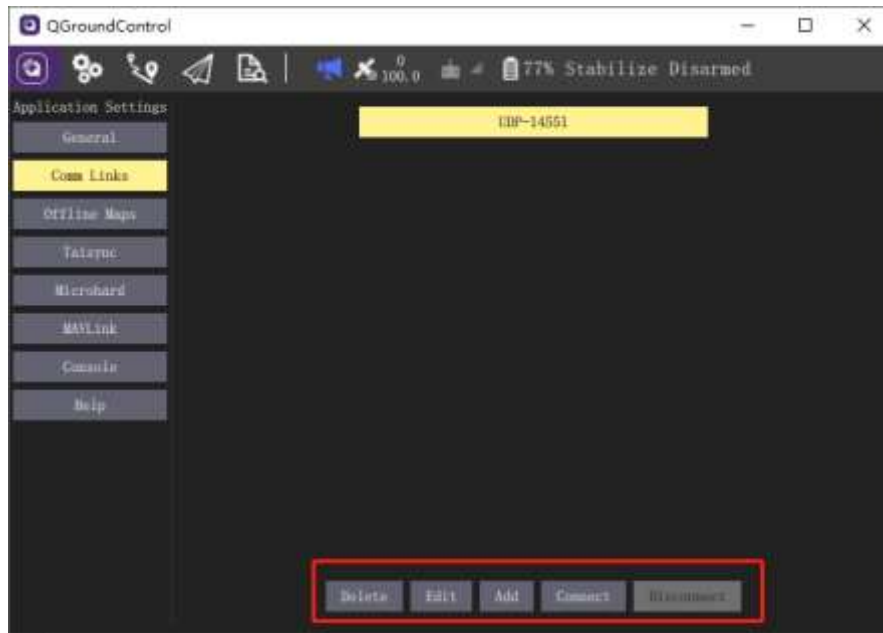

(4) The current version of QGroundControl ground station is unable to display the video. It is **recommended to use Feigong Ground Station** directly, including all the functions of QGroundControl ground station.

Mission Planner

1. The use of third-party ground stations needs to cooperate with **Feigong Transmission**. The use of Feigong Transmission is introduced in the above chapters. The forwarding communication can be completed by adding "information box".
2. it is necessary to confirm that the ground station receiving data and the network connection of Feigong Transmission are in the LAN. Then confirm the computer IP and data port of the ground station. If the ground station and Feigong Transmission are on the same computer, the IP address can be directly entered into "127.0.0.1". **The Windows computer obtains the IP method.** The port can be in the range of 1 - 65535. It is recommended to start from 14550. Note: If port occupancy is unavailable, please replace the port.
3. Now the local communication connection as an example. Adding data transmission for Feigong Transmission, protocol of UDP, IP of "127.0.0.1" , 14550 port and device.



4. Run Mission Planner Ground Station. Select the corresponding communication mode, click on the connection, if it is a network communication mode, you need to input the IP and Port. Because Feigong Transmission creates UDP-14550 "Information Box", here select UDP, click on the connection, and enter port 14550. As shown in the following steps:

(1) Operating on the corresponding options:



(2) Successful communication connection, data loading process:



5. Mission Planner Ground Station Display Video Function. Like data transmission, you need to create a corresponding "Information Box". As an example, the communication connection is carried out locally. Adding video transmission to Feigong Transmission results in a forwarding protocol of RTP, IP of "127.0.0.1" and port 5601. Note: It is necessary to confirm that the video stream has been successfully opened. the small icon in the upper right corner of the box.



6. Operating the corresponding options at the Mission Planner Ground Station. The Mission Planner Ground Station version is the test version 1.3.68. At present, for LTE-LINK SE, the video mode of "clear" and "smooth" is better supported, while the effect of other modes is not ideal. It is recommended to use the default port 5601, Mission Planner Ground Station can automatically detect video sources for display. If the video is displayed for the first time, you will be prompted to install the plug-in and click Installation. After installation, the Mission Planner ground station can be restarted and the video function can be used normally.



7. If you use other ports, you can also display the video function normally by performing the following steps:

(1) Right-click the mouse in the info box and select Setting Video Source



(2) Pop up the corresponding input box. If it is RTP transmission, modify the corresponding communication **Port**, modify port = port number. For example, modify port 5600 to copy and fill in information directly: `udpsrc port=5600 buffer-size=800000 ! application/x-rtp ! rtpvideo ! avdec_h265 ! videoconvert ! video/x-raw,format=BGRA ! appsink name=outsink`

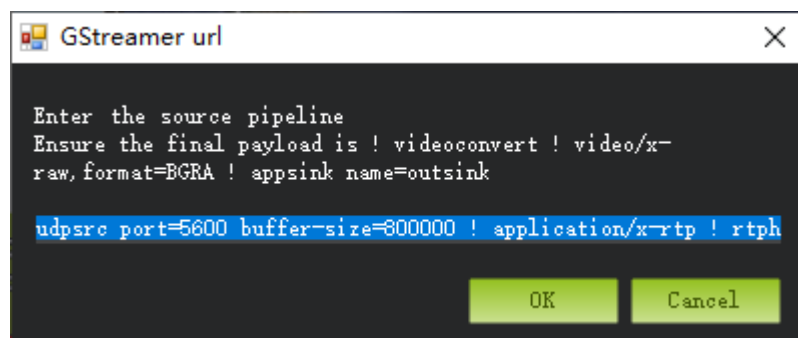

(3) Sometimes Video Parsing may need to wait several seconds for display, without affecting the real-time performance. Normal display effect:



Appendix

This section introduces the specifications and parameters of products, related problems and related methods involved in operation.

Appendix

Specifications

Product

| | |
|-------------------|---|
| Network Frequency | LTE (FDD): B1、 B3、 B8 LTE (TDD): B38、 B39、 B40、 B41 DC-HSPA+/HSPA+/HSPA/UMTS : B1、 B5、 B8、 B9 TD-SCDMA: B34、 B39 EDGE/GPRS/GSM : 900/1800 MHz |
|-------------------|---|

| | |
|--------------|--|
| Network Rate | DC-HSPA+: 下行:42 Mbps 上行: 5.76 Mbps LTE TDD: 下行:112Mbps 上行: 10Mbps LTE FDD: 下行:150 Mbps 上行: 50 Mbps |
|--------------|--|

| | |
|-----------|-------------------------------------|
| Autopilot | V5+、 V5 nano、 Pixhack、 Pixhawk. etc |
|-----------|-------------------------------------|

| | |
|---------------|-------------|
| Data Protocol | Mavlink 1/2 |
|---------------|-------------|

| | |
|-------------|---------------------------------------|
| Video Input | 1080P (1920*1080P) 、 720P (1280*720P) |
|-------------|---------------------------------------|

| | |
|--------------|---------------------------------|
| Video Output | 1080P、 720P、 480P、 320P - 30FPS |
|--------------|---------------------------------|

| | |
|-------------|------|
| Video Codec | H265 |
|-------------|------|

Interface Type

| | |
|------------|------|
| Data Input | UART |
|------------|------|

| | |
|-------------|------|
| Video Input | HDMI |
|-------------|------|

| | |
|---------|------|
| Antenna | MMCX |
|---------|------|

| | |
|------|-------------|
| OLED | OLED 128*64 |
|------|-------------|

Work Conditions

| | |
|---------------|----------|
| Voltage Input | 12 - 55V |
|---------------|----------|

| | |
|---------------------|-------------|
| Ambient Temperature | -20 - +70°C |
|---------------------|-------------|

Appearance Size

Size 75.3*39.2*19mm

Weight 78g

Relevant issues

1. Foreign usage. Is the server in China?

Answer: At present, the server is deployed in China. Overseas, if the network is smooth and the delay increases slightly, it can be used normally.

2. Supported 4G operators?

Answer: Support China Mobile, Telecom and Unicom. Operators in Hong Kong, Taiwan and Macao mostly support it. As for the use abroad, it is necessary to confirm that the band of local 4G operators corresponds to the network frequency in the specification parameter table before they can be used normally.

3. Supported autopilot type?

Answer: Autopilot supports Mavlink 1/2 protocols, such as V5+, V5 nano, Pixhack, Pixhawk, etc. Pay attention to the data port alignment between flight control systems. Flight control data does not support custom protocols.

4. Support camera input format?

Answer: As long as the camera output format is standard 1080P (1920*1080P), 720P (1280*720P) are basically supported, other input formats are not supported. Some displays are 1080P, but the actual resolution may be inconsistent.

5. Real-time data delay?

Answer: Real-time flight data delay is 30ms-50ms, depending on the network.

6. Real-time video delay?

Answer: There is no camera delay, the delay is 250 ms-450 ms, depending on the network and client decode.

7. 4G Network Communication Height?

Answer: The maximum height of specific 4G network communication depends on the coverage of local base stations. At our test site, LTE equipment can communicate data at 0-1000 meters.

8. Supporting multiple UAV?

Answer: The Feigong ground station based on QGroundControl ground station. At present, it is impossible to perform real-time multi-machine operation. If we want to operate, we can use Feigong Transmission, and then choose the third-party ground station software to support it.

Firmware Restore and Update

Device Restore: If the device fails to start properly, the device restore operation should be carried out to restore the operating system to the original version.

Note: the version restored does not support data communication. It needs to wait for network upgrade before the upgraded version can be used normally.

Restore process: Long press of the "Bind" button is required, and then the LTE device is powered on. Tip "Checked restore" and loosen the button. It must be prompted to release the button. In the process of restoring, power can not be cut off, which will lead to abnormal system. Just wait.



Device Update: If there is the latest version updates, the device will have prompt information, using automatic download updates. In the process of updating, power can't turn off, otherwise it may lead to the failure of updating and abnormal occurrence.

Windows access ip method

The way to get IP is shown in the following steps:

- (1) Use the shortcut key "win + r" to open the run dialog box:



- (2) In the "Open" option of the dialog box, enter "cmd" and click OK to enter the command interface:

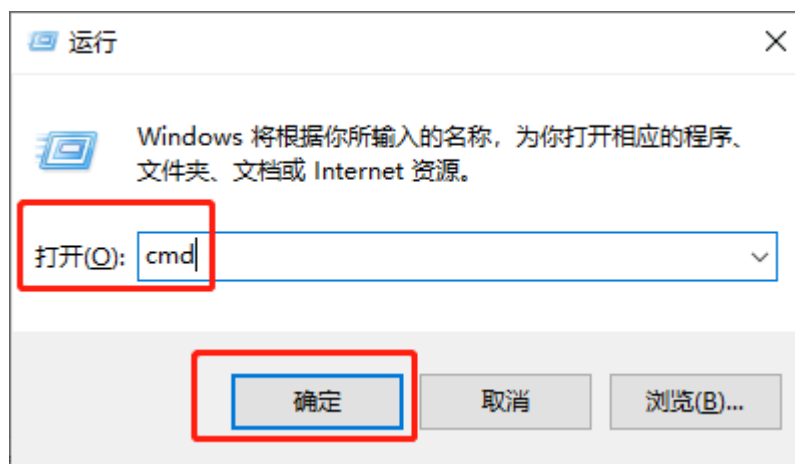

(3) Input "ipconfig", "Enter" to confirm:

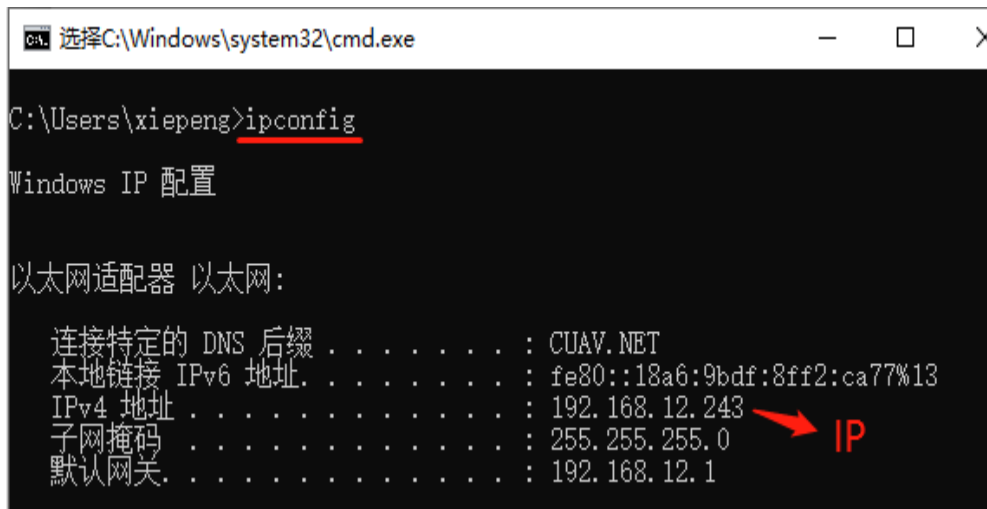

```
C:\Windows\system32\cmd.exe
C:\Users\xiepeng>ipconfig
Windows IP 配置

以太网适配器 以太网:

    连接特定的 DNS 后缀 . . . . . : CUAV.NET
    本地连接 IPv6 地址. . . . . : fe80::18a6:9bdf:8ff2:ca77%13
    IPv4 地址 . . . . . : 192.168.12.243
    子网掩码 . . . . . : 255.255.255.0
    默认网关. . . . . : 192.168.12.1
```