

X7+ Controller

Product manual

2022-12-6

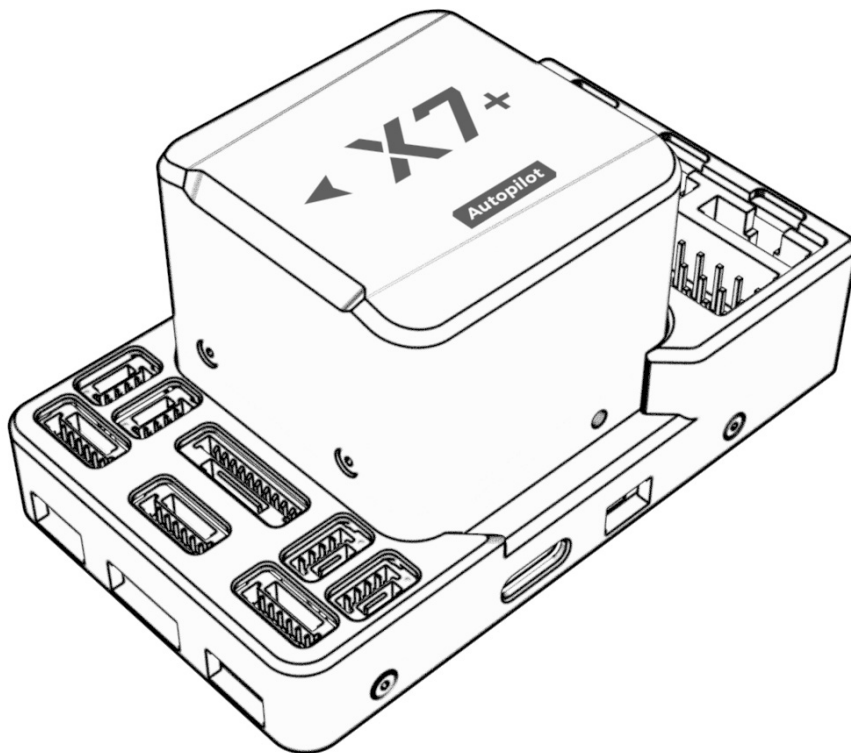

CUAV Tech Inc.,Ltd

Disclaimer

Please read the manual carefully before using it to make sure that you can use it correctly and safely. You need to install and use this product in strict accordance with the instructions. CUAV is not liable for any loss due to improper use. This manual is only used as a user guide. The company reserves the right to modify and improve the product details and instructions. The relevant data shall be subject to the data provided by our staff. CUAV does not guarantee the accuracy and reliability of the contents of the document.

This product is only a pure hardware component of an experimental unmanned system, and the firmware and software are provided by a third party. X7+ is only one of the components of unmanned system, and it has high requirements for use mode and compatibility of various components of unmanned system; CUAV only has the obligation to provide after-sales service within the product warranty period, and the company does not guarantee the reliability for any purpose; The company shall not be responsible for the direct, indirect, derivative, accidental injury and other losses or punishment caused by any reason or under any circumstances.

Copyright©CUAV, Without permission, do not copy the contents or reprint.

Product version history

This product is a continuation version of CUAV X7 controller, compatible with all the expansion hardware of the above products; except for the different compatible firmware, users can seamlessly replace it.

Online documentation

Please visit the CUAV docs for detailed tutorials and firmware downloads of this product:

<http://doc.cuav.net>

Download ground control station











[QGroundControl:](#)

https://docs.qgroundcontrol.com/en/getting_started/download_and_install.html

[Mission Planner:](#)

<https://firmware.ardupilot.org/Tools/MissionPlanner/MissionPlanner-stable.msi>

Parts List

X7+ Autopilot	X1	
I2C / CAN cable	X2	
ADC3.3 cable	X1	
RSSI cable(X7 series)	X1	
CAN PMU Lite Power Module	X1	
Dupont cable	X1	
CAN extension board	X1	
Pw-Link module	X1	
USB-TypeC cable	X1	
16G Memory card	X1	

Hardware specifications

Item	Parameter
MCU	STM32H743
Sensor	ICM-42688-P/ICM-20689/ICM-20689/RM3100/MS5611/MS5611
UART	5
I2C	6(4 separate i2c interfaces,2 integrated in GPS / uart 4 interface)
PWM output	14 (12 of which support dshot protocol)

RC in	1(Compatible with DSM / SBUS / PPM remote control signal protocol)
RSSI input	PWM or 3.3 analog voltage
CAN bus	2
Power input	2 (Power A is the common ADC power detection interface; Power C is the CAN ammeter interface)
Safety switch	1
GPS interface	2 (UART4 can be used as GPS2 interface)
ADC	1
Debug	1
JATG	1
USB interface	1
Supported models	
ArduPilot	All models supported by ArduPilot firmware
PX4	All models supported by PX4 firmware
Controller Working environment and physical Spec	
PM operating voltage	4.5 ~ 5.5 V
USB input voltage	4.75 ~ 5.25 V
Servo input	0 ~ 10v
Operating temperature	-20 ~ 85°C
Environment humidity	5%~95% (non-condensing)
Weight	101g

Support firmware

X7+ controller runs perfectly with ArduPilot 4.10/PX4 V1.12.3 and above firmware.

Firmware and source code

X7+ supports PX4 and ArduPilot firmware, the compiled firmware

Download and write firmware tutorial:

<https://doc.cuav.net/controller/x7/en/ardupilot-users-manual.html#ardupilot-firmware>

If you want to modify the code; you can download the source code through the link below

ArduPilot Github :

<https://github.com/ArduPilot/ardupilot>

PX4 Github :

<https://github.com/PX4/PX4-Autopilot>

Compile firmware command(ArduPilot):

```
./waf configure --board CUAV-x7 //Compile CUAV X7 branch firmware  
./waf copter --upload //Write the firmware to the controller
```

Compile firmware command(PX4):

```
make cuav_x7pro_default //Compile CUAV X7 Pro branch firmware
```

Note:

X7+ supports (ArduPilot) CUAV X7 branch firmware and (PX4) CUAV X7 pro branch firmware.

Pinouts

The design of the X7+ interface uses Pixhawk standard pinouts. Please read the description of the interface definition carefully and use the original wiring of the product. If the wiring is not used according to the standard defined by the interface, the company will not compensate for the damage to the equipment.

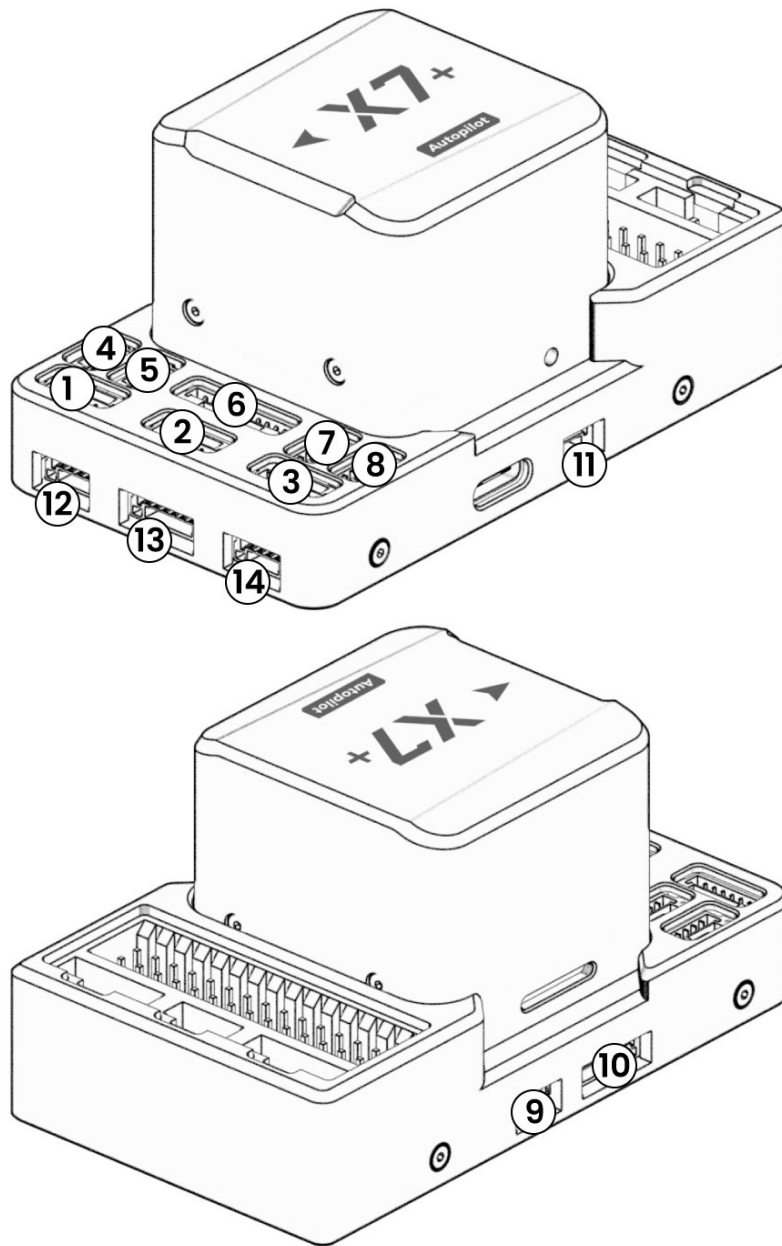

01 TELEM 1

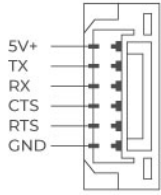

02 UART4

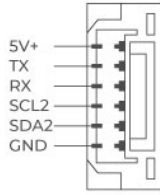

03 TELEM 2

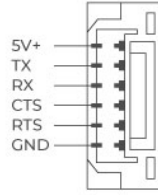

04 CAN 2

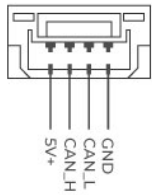

05 CAN 1

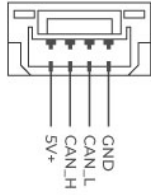

06 GPS&SAFETY

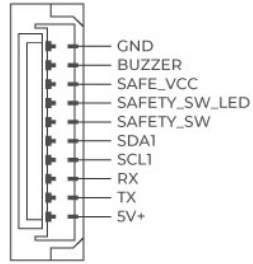

07 I2C 2

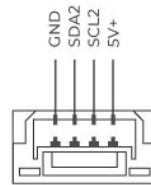

08 I2C 1

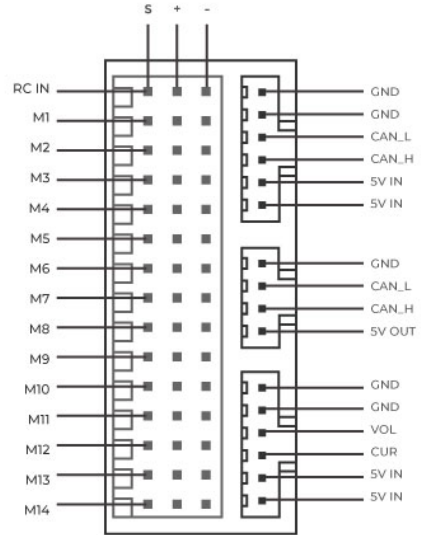
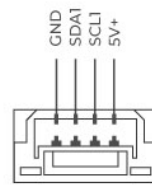

09 ADC

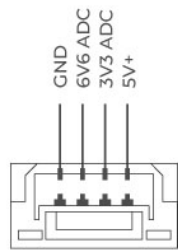

10 SPI 5

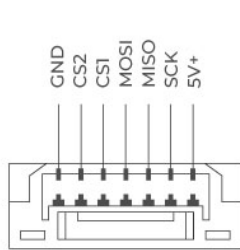

11 RSSI

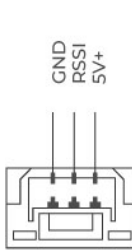

12 I2C3

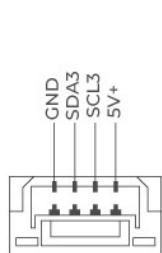

13 DEBUG&UART7 14 I2C4

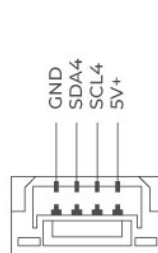
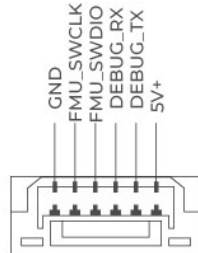

Hardware connection diagram

Take the quadcopter as an example:

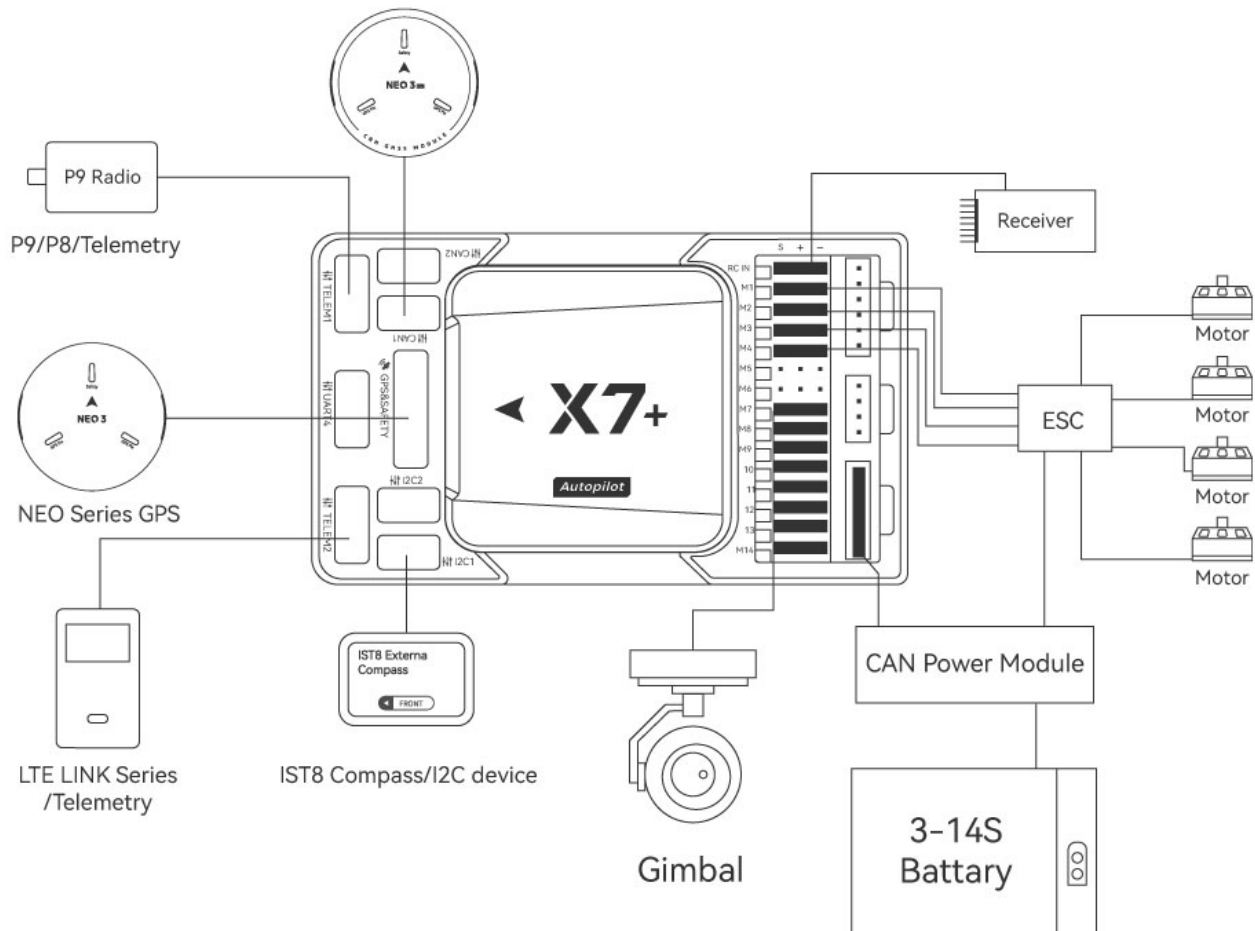

Product connection

Interface	Connected accessories
M1-M14	PWM signal output port, They can be connected to ESC and servo
RCIN	Connect PPM / DSM / SBUS remote control receiver
Power A	Connect HV_PM or other analog ammeter
Power C	Connect to CAN protocol power management module such as CAN PMU Lite or CAN PMU
GPS&SAFETY	Connect GPS and safety switch
TELEM1	Connect P9 or other data transmission

TELEM2	Connect LTE LINK series or data transmission
I2C1/2/3/4	Connect IST8310 compass or other I2C devices
CAN1/CAN2	Connect to CAN GPS or other CAN devices (such as NEO V2 PRO/NEO 3 PRO)
UART4	Digital transmission or GPS2, etc.
RSSI	Telemetry signal strength input, receiver with RSSI output

Certification



Product has passed
CE certification



Product has passed
CE certification



CUAV has passed
ISO 9001 quality management
system certification

More information

CUAV official website: www.cuav.net

For more usage and assembly instructions, please visit the document center: doc.cuav.net